(1)

(2)

(3) TQWX-III

DL-31

DL-31

DL-31

0.8

2-3

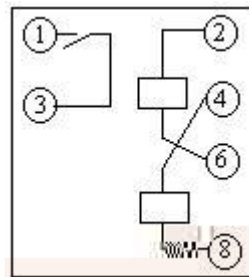

2-3 DL-31

(1)

(2)



2-4 I_a
 I I_n
 2-4 1
 24V+ 24V- A K

24V+

A

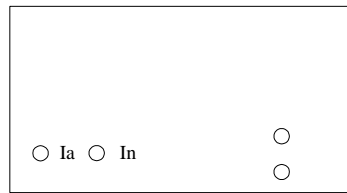
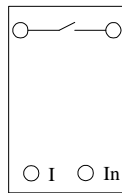

2-4

3.5A

(1)

a.

PC

2-5

b.

2-6

2-7

I_a

2-4

A

0.05A

2-4

1

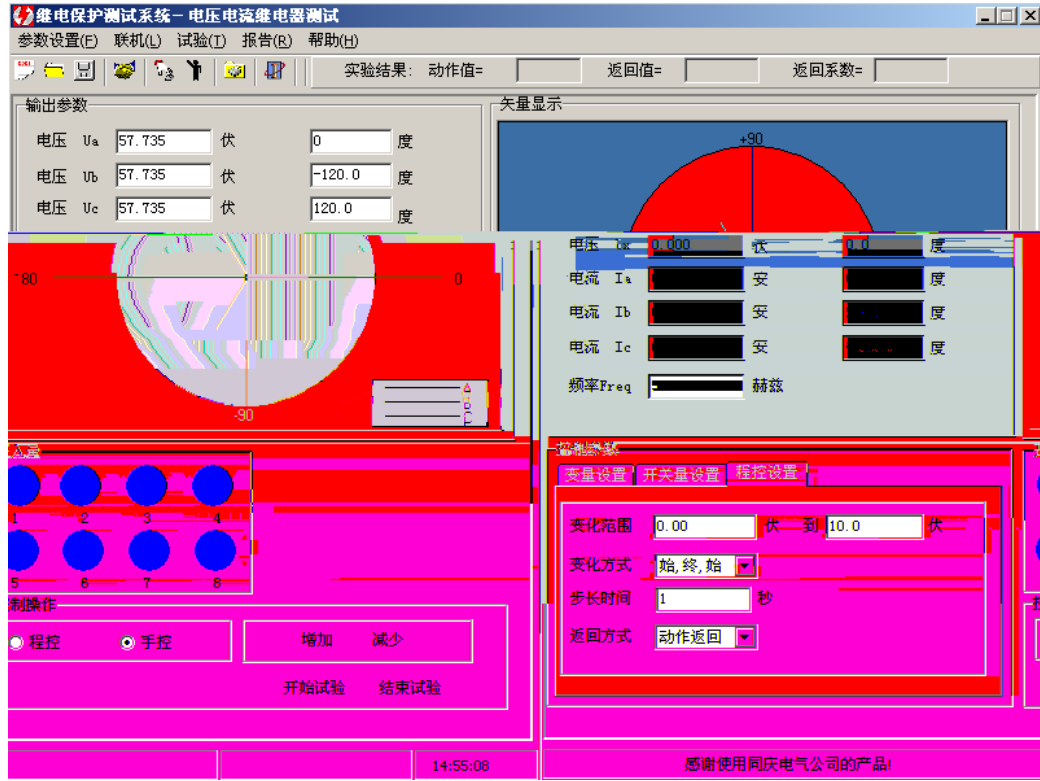

2-5

c.

I_a

0

d.

e.

TQWX-III

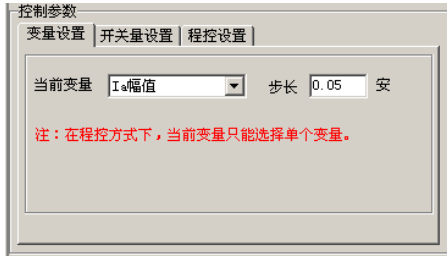

2-6



2-7

f.

g.

$$\frac{[\quad] / \quad \times 100\%}{[\quad] / \quad \times 100\%}$$

$$\frac{\quad}{\quad}$$

2-1

h.

4.5A

2-1

2-2

2-1

3.5A

	(A)	(A)	
1			
2			
3			
4			
(A)			/
(%)			
(%)			

2-2

	(A)	
1	3.5	
2	4.5	

(2)

a. 2-5

b.

2-8

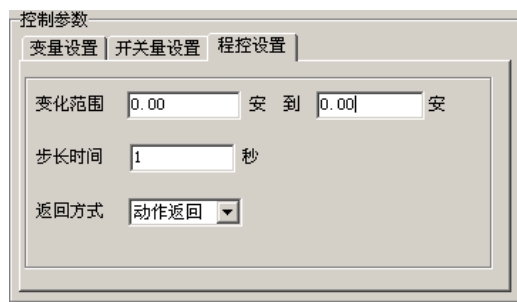

2-8

0.5s

c.

(1)

(2)

-
- (1)
 - (2)
 - (3) DY-36

DY-36

DY-36

! !

2-9

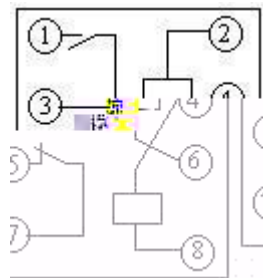

2-9 DY-36

2-10

U_a U_n

U U_n

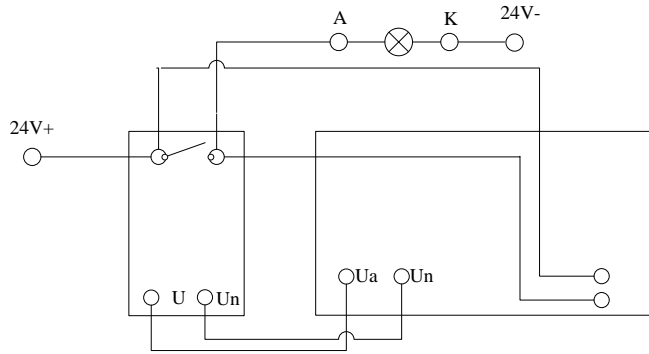

2-10

50V

(1)

a. 2-10

b. PC

c. 2.2 U_a

3 2-3

2-3 50V

	(V)	(V)	
1			
2			
3			
(V)			/
(%)			
(%)			

--	--

(2)

a. 2-10

b.

0
A 55V 0.5V
 U_a

3

2-4

2-4

	(V)	(V)	
1			
2			
3			
(V)			/
(%)			
(%)			
(V)	50		

(1)

(2)

(3)

(1)

(2)

LCD-4

LCD-4

LCD-4

2-18

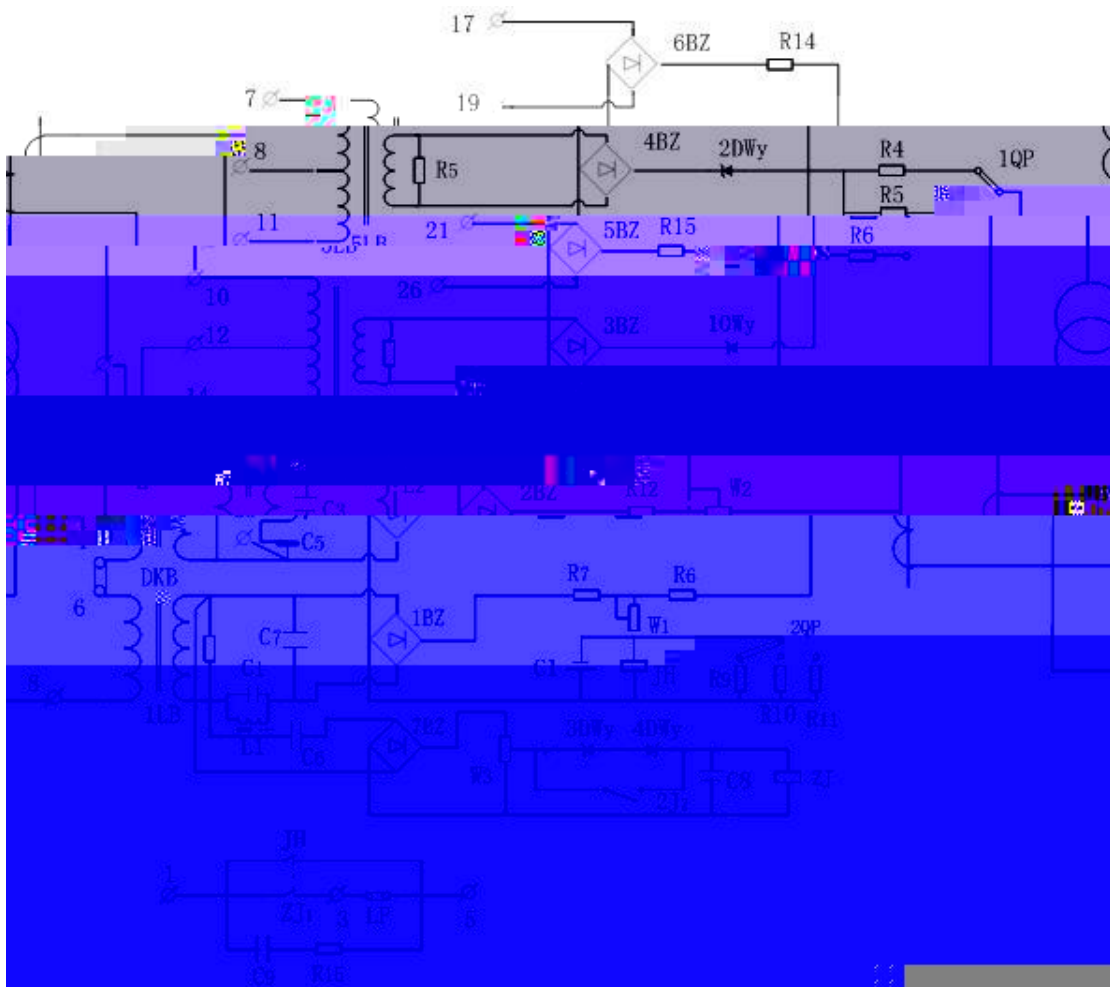

2-18 LCD-4

1LB

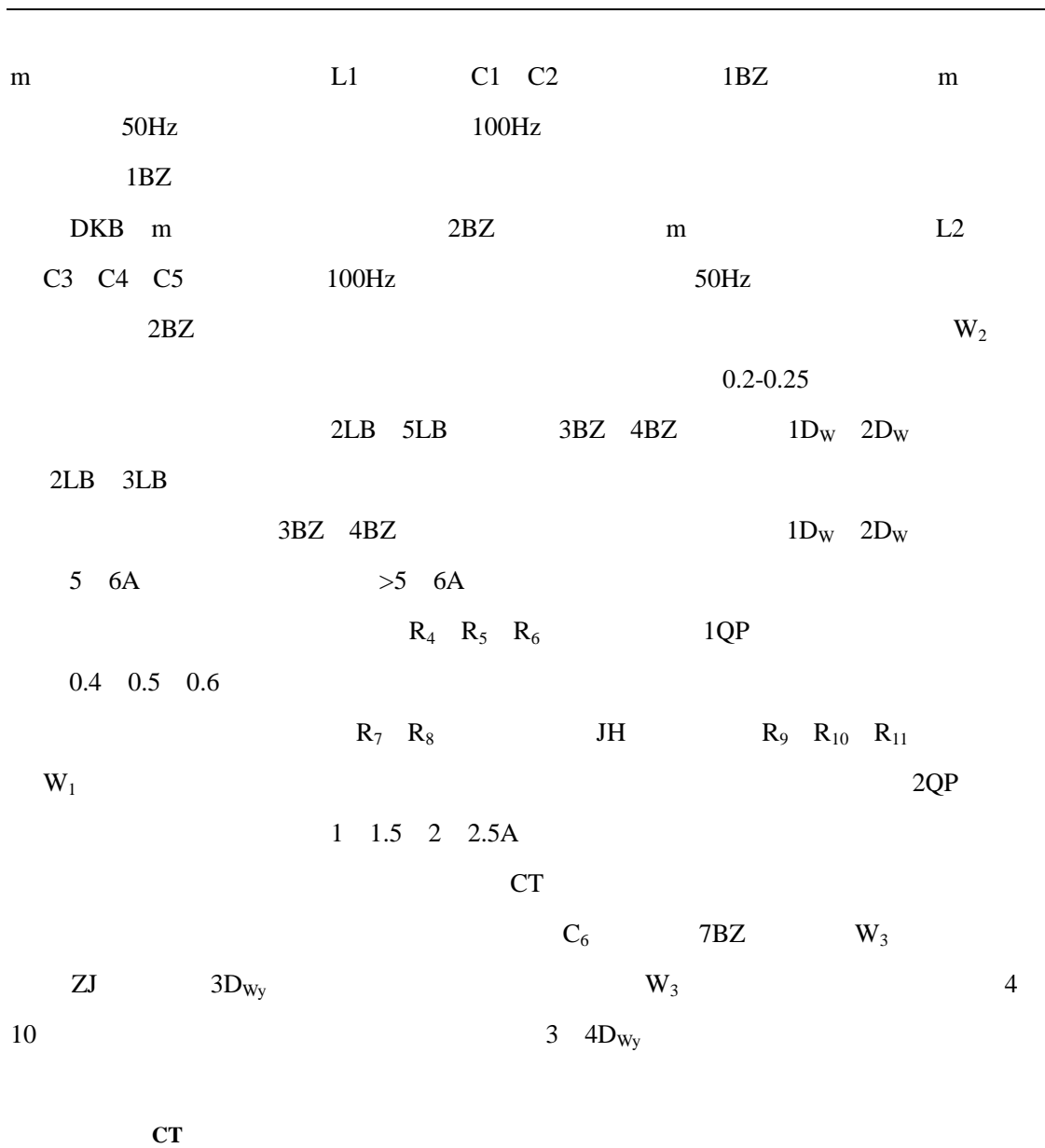

1 2.5A

1A 1.5A 2A 2.5A

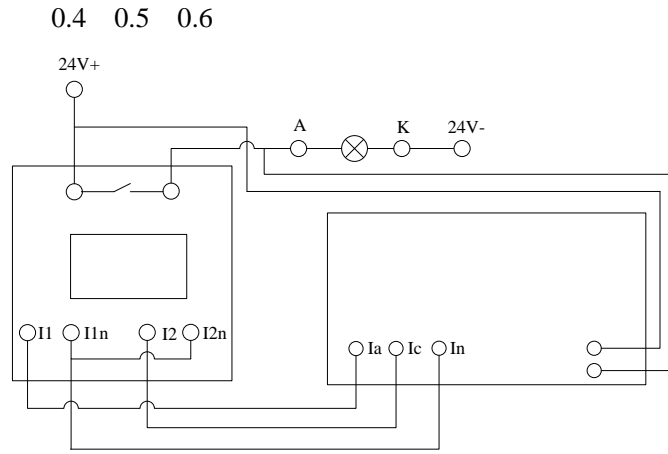

2-19

(1) 2A 0.5

(2) PC

(3)

I_1, I_2 I_1 I_2 I_2
 I_d I_1 0 I_2

180

(I_d, I_r)

LCD-4

$$I_d = I_1 + I_2 \quad I_r = I_1 - I_2$$

2-20

I_r

I_r

I_r

I_r

2A 10A 0.5A

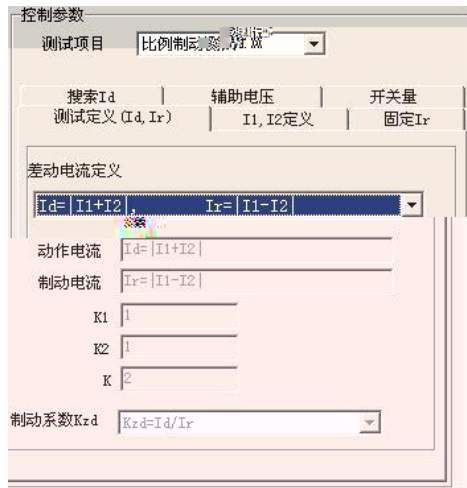

2-20 (I_d I_r)

I_d I_r I_d 2-21 (I_d I_r)
 TQWX-III

I_d 10 100 I_d 2A 1
 1 0.01A

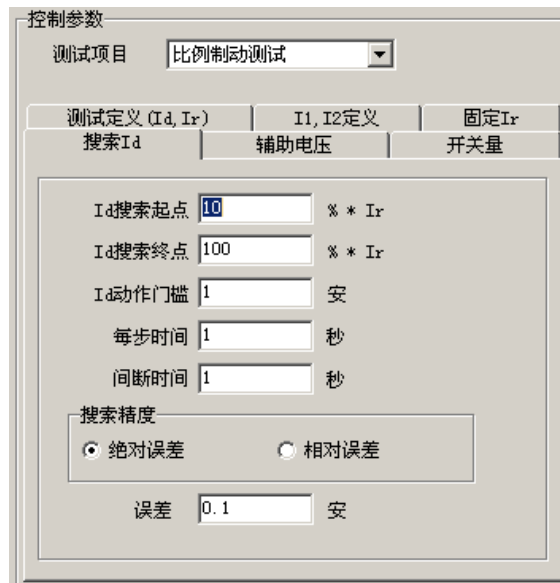

2-21 I_d

I_d 1
 100
 (4) I II II
 I2
 K_{zd} I_d I_r
 (5)

(6) 0.4 0.6 3-5
 $I_d = f(I_r)$

(1)

(2)

-
- (1)
 - (2)
 - (3)

- (1)
-

$$I_{pu} = K_{rel}^I \frac{E'}{X_S + X_0 L}$$

$$E' \qquad X_S \qquad X_0$$

$$L \qquad K_{rel}^I$$

1.2~1.3

- (2)
-
-

$$L_1 = \frac{L}{K_{rel}} \quad 0.75L$$

$$K_{rel} \qquad 1.3 \sim 1.4$$

$$I_{pu} = \frac{E'}{X_S + X_0 L_1}$$

E'

X_S

X_0

$L_1 = 0.75 L$

I_{pu}

$U_{pu} = \sqrt{3} I_{pu} X_0 L_1$

2-22

A 3QF

DL-31

DZY-202

2-23

DL-31

DY-36

2-25

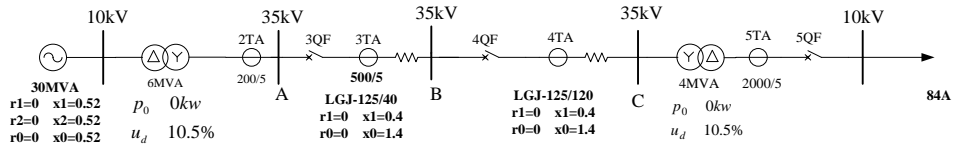

2-22

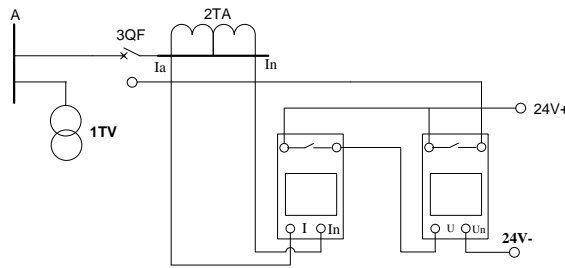

2-23

(1)

2-23

3QF

I_a I_n

DL-31

I I_n

(2)

2-22

2-13

DL-31

(3)

.ddb

.ddb

a.

2-24 AB

1 99

R_f R_g 0

0 0

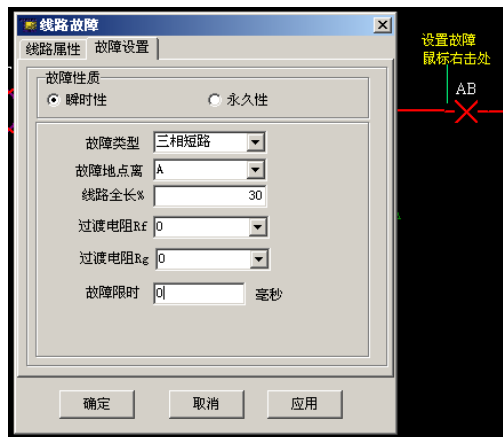

2-24

0% 100%

b.

c.

3QF

d.

e.

3QF

f.

a-e

2-13

g. AB AB
2-13

2-13

	(A)	(V)		
				AB
	5.03			
	4.55	15.6		

(1)

2-25 3QF (3TV)
 U_a U_b DY-36 U U_n 3QF
 (TA) I_a I_n DL-31 I I_n 3QF
 3QF

(2)

2-13

100V

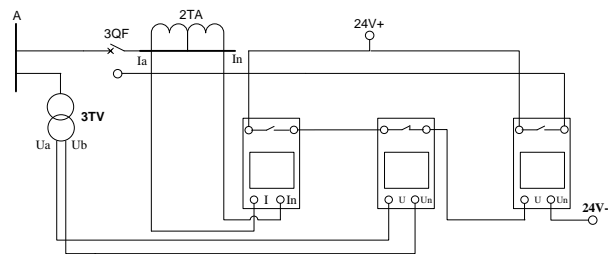

2-25

(3)

AB

2-13